

Product Specification

Product class	Item No	Material
Lens	DK-15-48-LENS-H8.6-3535	PMMA
LED Holder	DK-78*26-ZJ-EM-BK	PC

Content

Specification-----	3
2D Drawing-----	4
Optical Datasheet-----	5
Packing-----	6
Application Notes-----	7

Specification

Item No	Picture	Size	Matched LED	Lighting Application
DK-15-48-LENS-H8.6-3535		Diameter: ϕ 14.9mm Height: 8.63mm FWHM: 48°	3535	outdoor lamp
DK-78*26-ZJ-EM-BK		Diameter: ϕ 77.97mm Height: 25.96mm		

Drawing

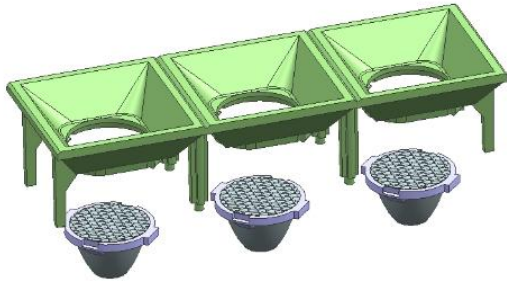
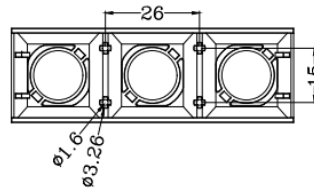
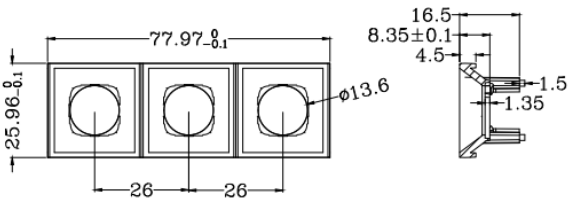
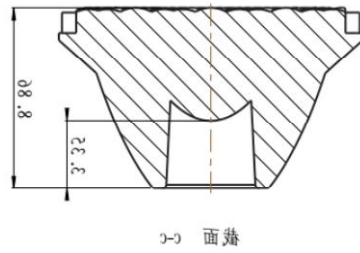
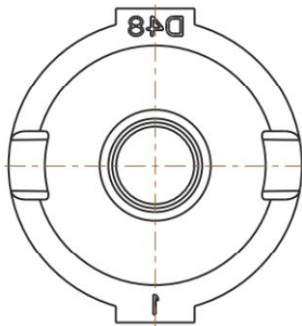
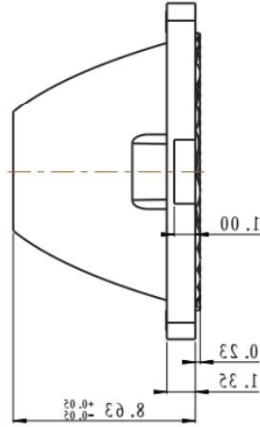
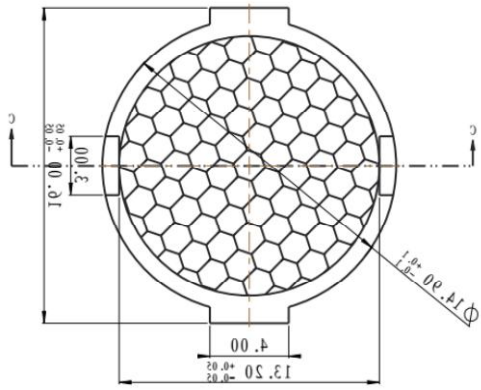

Optical Test Report

产品特征

灯具制造厂商:

光源个数: 1
发光面长度(mm): 0 mm
发光面高度(mm): 0 mm

光源光通量: 75.7 lm
发光面宽度(mm): 0 mm
功率: 0.00 W

光度结果

灯具CIE分类: 直接型
灯具光通量: 75.7 lm
下射光通量比: 99.99%
水平扩散角(50%): H45.3
垂直扩散角(50%): V48.4
灯具光效等级(LER): 75.74
峰值光强: 109.27 cd
S/MH(C0/C180): 0.81

额定光通量: 75.7 lm
灯具效率: 99.99%
上射光通量比: 0.00%

中心光强: 92.45 cd
峰值光强位置: H180 V13
S/MH(C90/C270): 0.80

灯具实物照片

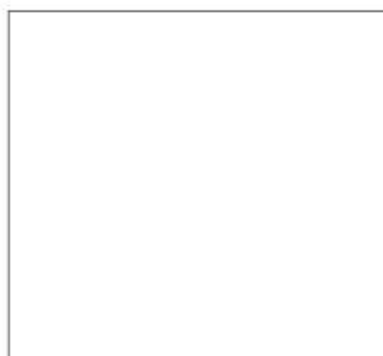

配光曲线

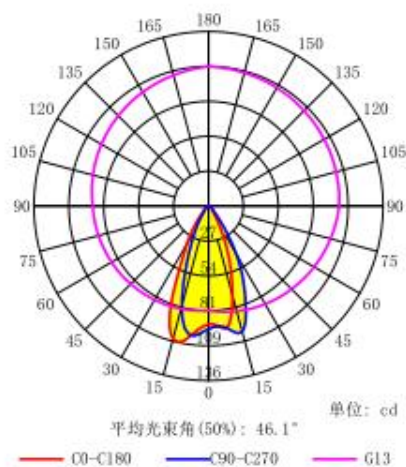

配光曲线

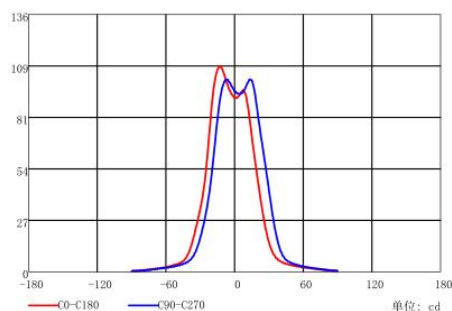
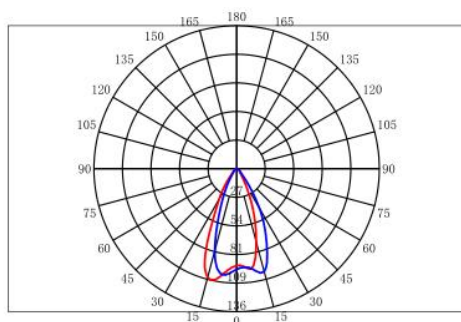

Packing Details

Material	Size	Packing Instruction
EPE	150*120mm	560PCS/1 Box 24 Box/1 Carton
White Paperboard	150*115mm	
Box	160*120*80mm	
Carton	A=B 510*330*255mm	

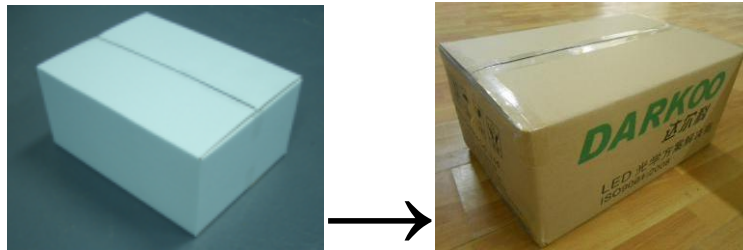

Application Notes

(1) Please use a little water and soft fabric (air-laid paper) to clean the product if necessary.

(2) Forbid to use industrial solvent to clean the product, such as alcohol.

(3) The working temperature is $-40^{\circ}\text{C}\sim+80^{\circ}\text{C}$ (PMMA) or $-35^{\circ}\text{C}\sim+120^{\circ}\text{C}$ (PC).

(4) Storage environment temperature is $0^{\circ}\text{C}\sim40^{\circ}\text{C}$, humidity is 30%~95%.

(5) The product has the function to change the ray of light, it is made of optical material, the effect shall be influenced once pollute. Please do not open the packing before use it, to avoid the dust pollution.

(6) Protect the product from the sun and other ultraviolet ray, as these will lead to aging, change color, crack, etc.

(7) Please wear gloves once install the product, avoid to abrasion the product surface.

(8) Forbid to use acidic or alkaline solution touch the product, avoid to generate the chemical reactions.