

Product Specification

Product class	Item No	Material
Lens	DK-15-10-LENS-H8.6-3535	PMMA
LED Holder	DK-78*26-ZJ-EM-BK	PC

Content

Specification-----	3
2D Drawing-----	4
Optical Datasheet-----	5
Packing-----	6
Application Notes-----	7

Specification

Item No	Picture	Size	Matched LED	Lighting Application
DK-15-10-LENS-H8.6-3535		Diameter: ϕ 14.9mm Height: 8.63mm FWHM: 16.4°	3535	outdoor
DK-78*26-ZJ-EM-BK		Diameter: ϕ 77.97mm Height: 25.96mm		

Drawing

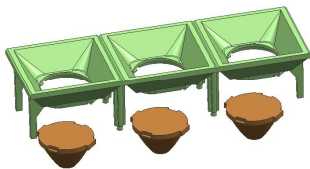
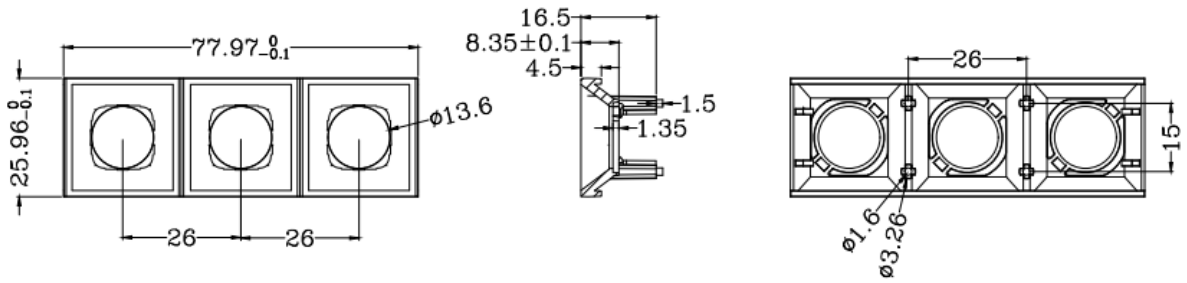
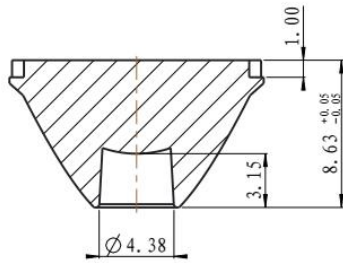
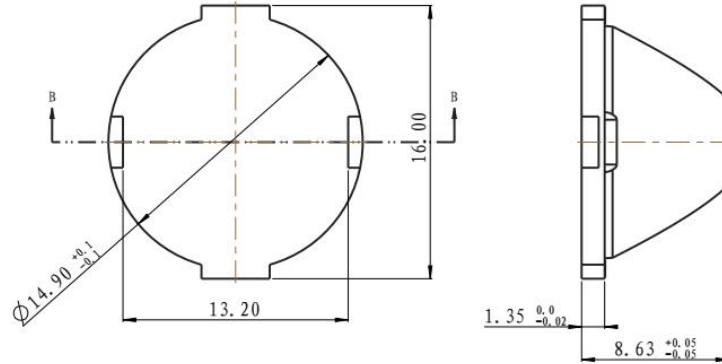

Optical Test Report

产品特征

灯具制造厂商:
光源型号: 3535带帽
电压: 3.5 V
电流: 0.395 A
功率: 1.38 W
功率因数: 1.000

光度结果

灯具CIE分类: 直接型
灯具光通量: 140.1 lm
额定光通量: 140.1 lm
灯具效率: 100%
下射光通量比: 100%
上射光通量比: 0%
水平扩散角 (10%, 50%, 75%, 100%): H33. 2, H16. 4, H11. 5, H1
垂直扩散角 (10%, 50%, 75%, 100%): V33. 1, V16. 4, V11. 3, V0
灯具光效等级 (LER): 101.56
中心光强: 969.56 cd
峰值光强位置: H90 V0
S/MH(C0/C180): 0.28
S/MH(C90/C270): 0.28

灯具实物照片



配光曲线

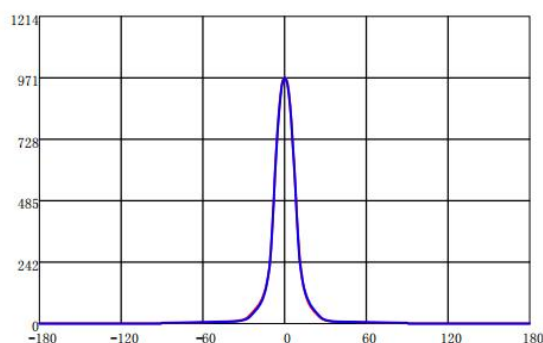
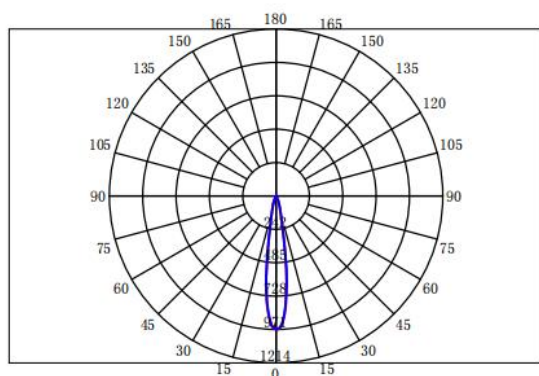
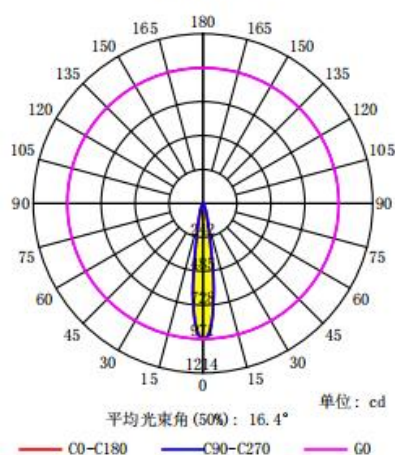

Packing Details

包材名称	包材规格	合计数量
PVC 防静电吸塑盒	DK-15-H86-LENS	130PCS/吸塑盒
中纸箱	335*245*105mm	1300PCS/箱
外箱	510*330*255mm	5200PCS/箱



Application Notes

(1) Please use a little water and soft fabric (air-laid paper) to clean the product if necessary.

(2) Forbid to use industrial solvent to clean the product, such as alcohol.

(3) The working temperature is $-40^{\circ}\text{C}\sim+80^{\circ}\text{C}$.

(4) Storage environment temperature is $0^{\circ}\text{C}\sim40^{\circ}\text{C}$, humidity is 30%~95%.

(5) The product has the function to change the ray of light, it is made of optical material, the effect shall be influenced once pollute. Please do not open the packing before use it, to avoid the dust pollution.

(6) Protect the product from the sun and other ultraviolet ray, as these will lead to aging, change color, crack, etc.

(7) Please wear gloves once install the product, avoid to abrasion the product surface.

(8) Forbid to use acidic or alkaline solution touch the product, avoid to generate the chemical reactions.